

Silicon Carbide Power MOSFET (N-Channel Enhancement)

V_{DS}	1200V
I_D (25°C)	78A
$R_{DS(on)}$	40mΩ

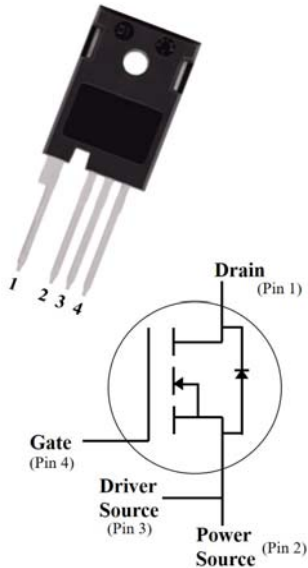

Features

- High speed switching
- Essentially no switching losses
- Reduction of heat sink requirements
- Maximum working temperature at 175 °C
- High blocking voltage
- Fast Intrinsic diode with low recovery current
- High-frequency operation
- Halogen free, RoHS compliant
- AEC-Q101 qualified

Typical Applications

Typical applications are in power factor correction(PFC), solar inverter, uninterruptible power supply, motor drives, photovoltaic inverter, electric car and charger.

Mechanical Data

- **Package:** TO247-4L
- **Terminals:** Tin plated leads
- **Polarity:** As marked

■Maximum Ratings ($T_C=25^\circ\text{C}$ Unless otherwise specified)

PARAMETER	SYMBOL	UNIT	VALUE	TEST CONDITIONS	NOTE
Device marking code			D212040NCFGH2		
Drain source voltage @ $T_j=25^\circ\text{C}$	$V_{DS,max}$	V	1200	$V_{GS}=0\text{ V}$, $I_D=100\mu\text{A}$	
Gate source voltage @ $T_j=25^\circ\text{C}$	$V_{GS,max}$	V	-10/+22	Absolute maximum values (AC f > 1Hz, duty cycle < 1%)	
Gate source voltage @ $T_j=25^\circ\text{C}$	$V_{GS,op}$	V	-5/+18	Recommended operational values	
Continuous drain current @ $T_c=25^\circ\text{C}$	I_D	A	78	$V_{GS}=18\text{V}$, $T_c=25^\circ\text{C}$	Fig.14
Continuous drain current @ $T_c=110^\circ\text{C}$			53	$V_{GS}=18\text{V}$, $T_c=110^\circ\text{C}$	
Pulsed drain current	$I_{D(pulsed)}$	A	349	Pulse width t_p limited by $T_{j,max}$	Fig.15
Avalanche energy, Single Pulse	E_{AS}	J	2.5	$V_{DB}=100\text{V}$, $I_D=14\text{A}$	
Power Dissipation	P_{TOT}	W	375	$T_c=25^\circ\text{C}$, $T_j = 175^\circ\text{C}$	Fig.13
Operating junction and Storage temperature range	T_j, T_{stg}	$^\circ\text{C}$	-55 to +175		
Soldering temperature	T_L	$^\circ\text{C}$	260	1.6mm (0.063") from case for 10s	
Mounting torque	T_M	Nm	1.0	M3 screw Maximum of mounting process: 3	



■Static Electrical Characteristics (Tc=25°C unless otherwise specified)

PARAMETER	SYMBOL	UNIT	Min.	Typ.	Max.	Test Conditions	Note
Gate threshold voltage	$V_{GS(th)}$	V		2.7		$V_{DS}=V_{GS}$, $I_D=50mA$	Fig.4, 11
Drain source breakdown voltage	$V_{(BR)DSS}$	V	1200			$V_{GS}=0$, $I_D=100\mu A$	
Zero gate voltage drain current	I_{DSS}	μA		<1	50	$V_{DS}=1200V$, $V_{GS}=0V$	
				10	500	$V_{DS}=1200V$, $V_{GS}=0V$, $T_J=175^\circ C$	
Gate source leakage current	I_{GSS}	nA			250	$V_{GS}=18V$, $V_{DS}=0V$	
Current drain source on-state resistance	$R_{DS(on)}$	m Ω		40	50	$V_{GS}=18V$, $I_D=40A$	Fig.3, 5, 6
				54		$V_{GS}=18V$, $I_D=40A$, $T_J=175^\circ C$	
Transconductance	g_f	S		17		$V_{DS}=15V$, $I_D=40A$	

■Dynamic Electrical Characteristics (Tc=25°C unless otherwise specified)

PARAMETER	SYMBOL	UNIT	Min.	Typ.	Max.	Test Conditions	Note
Input capacitance	C_{iss}	pF		4909		$V_{DS}=800V$, $V_{GS}=0V$, $T_J=25^\circ C$, $f=1MHz$, $V_{AC}=25mV$	Fig.10
Output capacitance	C_{oss}			195			
Reverse capacitance	C_{rss}			34			
Coss stored energy	E_{oss}	μJ		79			Fig.12
Gate source charge	Q_{gs}	nC		91		$V_{DS}=800V$, $V_{GS}=-5/18V$, $I_D=40A$	Fig.16
Gate drain charge	Q_{gd}			88			
Gate charge	Q_g			280			
Internal Gate Resistance	$R_{G(int)}$	Ω		0.7		$f=1MHz$, $V_{AC}=25mV$	

■Switching Characteristics (Tc=25°C unless otherwise specified)

PARAMETER	SYMBOL	UNIT	Min.	Typ.	Max.	Test Conditions	Note
Turn on switching energy	$t_{d(on)}$	ns		30		$V_{DD}=800V$, $V_{GS}=-4/+18V$, $I_D=40A$, $R_L=20\Omega$, $R_{G(ext)}=2.2\Omega$	
Turn off switching energy	t_r			53			
Turn on delay time	$t_{d(off)}$			8			
Rise time	t_f			12			
Turn off delay time	E_{on}	μJ		1117		$V_{DD}=800V$, $V_{GS}=0/+18V$, $I_D=40A$, $R_{g(ext)}=2.2\Omega$	Fig.17, 18
Fall time	E_{off}			677			



■Body diode characteristics (Tc=25°C unless otherwise specified)

PARAMETER	SYMBOL	UNIT	Min.	Typ.	Max.	Test Conditions	Note
Diode forward voltage	V _{SD}	V		3.0		V _{GS} =0V, I _{SD} =10A	Fig.8
Continuous diode forward current	I _S	A		50		V _{GS} =0V, Tc=25°C	
Reverse recovery time	t _{rr}	nS		79		V _{DS} =400V, V _{GS} =0V, I _{SD} =30A, di/dt=300A/uS	
Reverse recovery charge	Q _{rr}	nC		284			
Peak reverse recovery current	I _{rrm}	A		6.8			

■Thermal Characteristics (T_a=25°C Unless otherwise specified)

PARAMETER	SYMBOL	UNIT	Value
Thermal resistance	R _{θJ-C}	°C/W	0.4

■Typical Characteristics

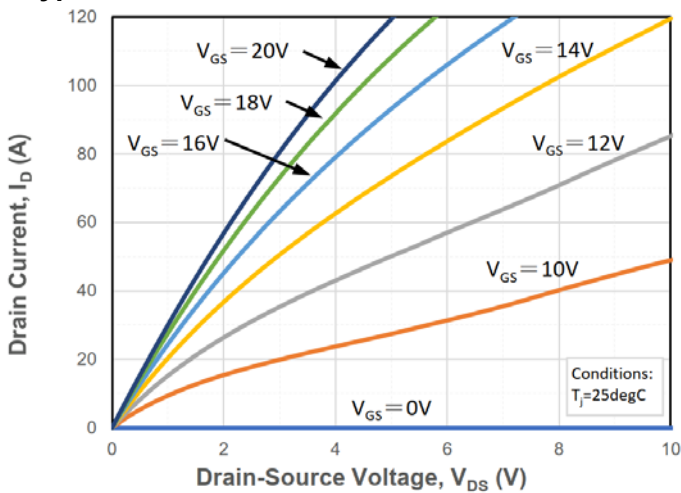

Figure 1. Output Characteristics T_j = 25°C

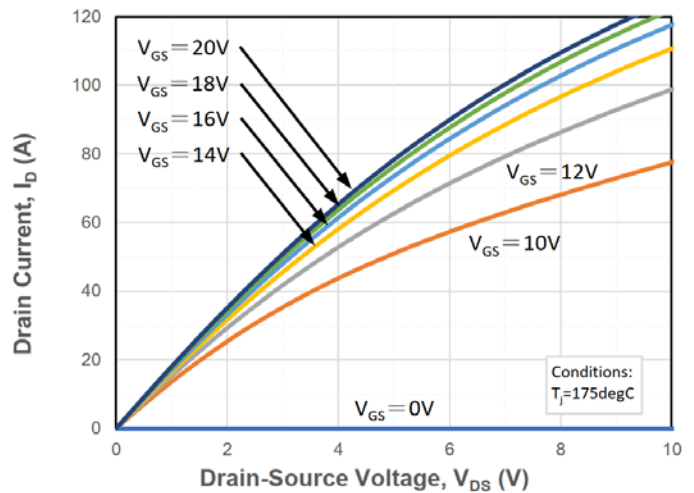

Figure 2. Output Characteristics T_j = 175°C

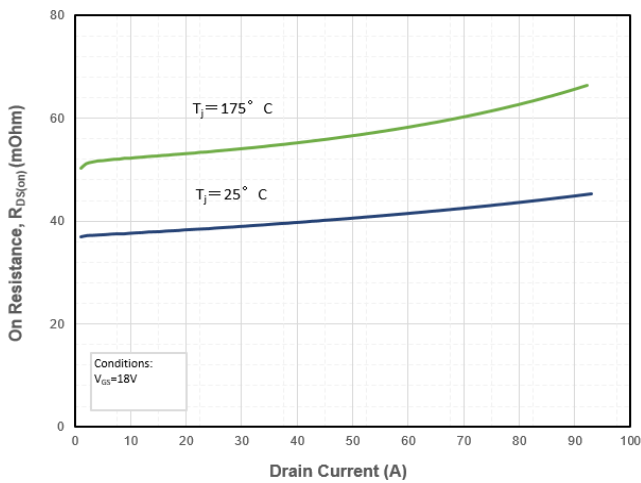

Figure 3. On-resistance vs. drain current

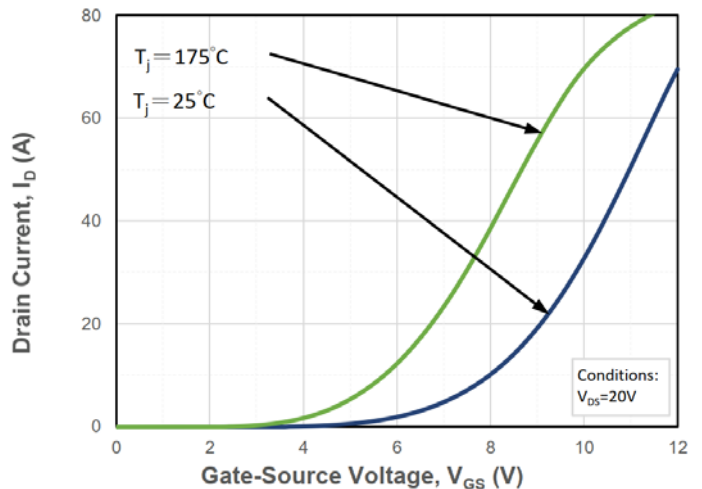

Figure 4. Transfer Characteristics for various T_j



YJD212040NCFGH2Q

RoHS
COMPLIANT

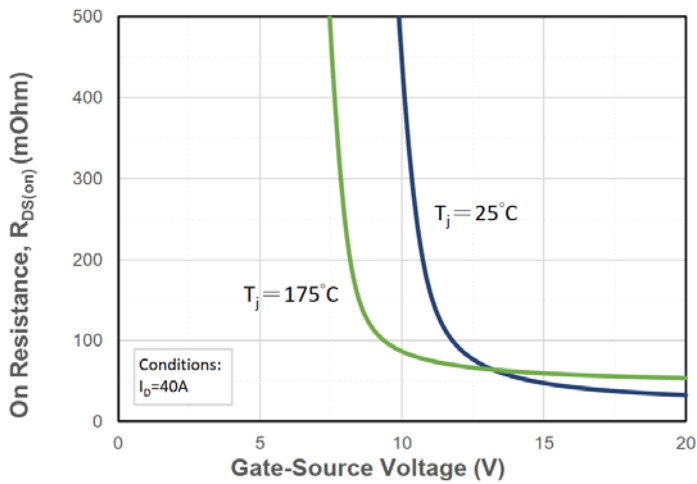

Figure 5. On-resistance vs. gate voltage for various Tj

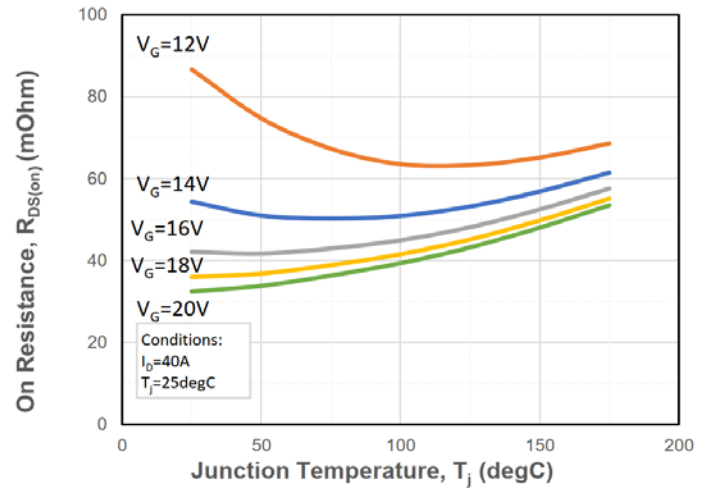

Figure 6. On-resistance vs. Temperature for various Gate voltage

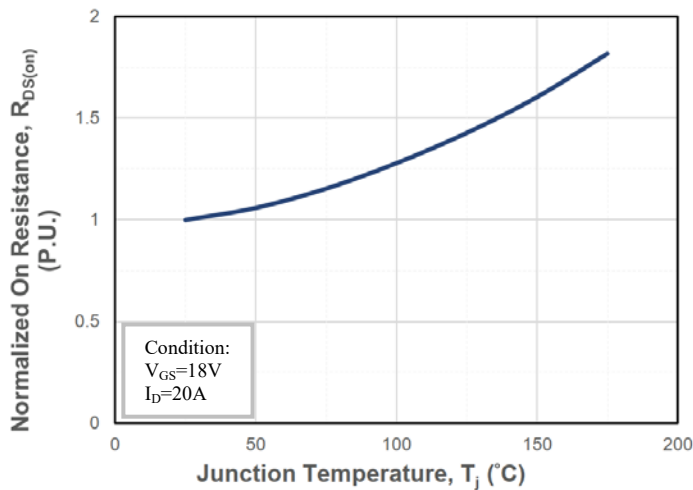

Figure 7. Normalized On-Resistance vs. Temperature

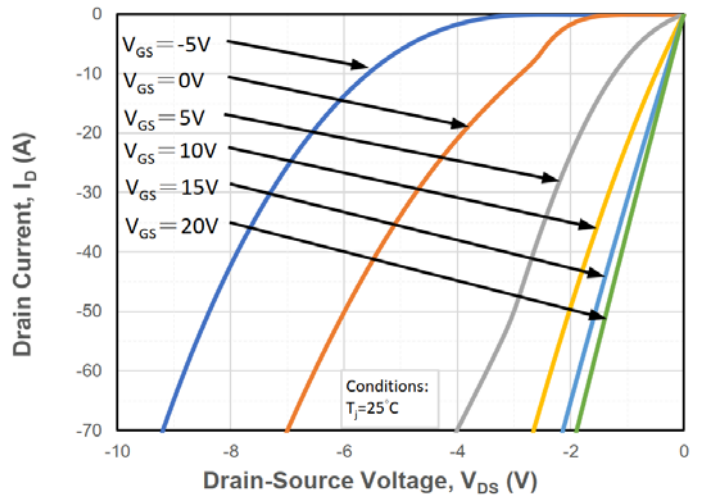

Figure 8. Reverse Output Characteristics at Tj = 25°C

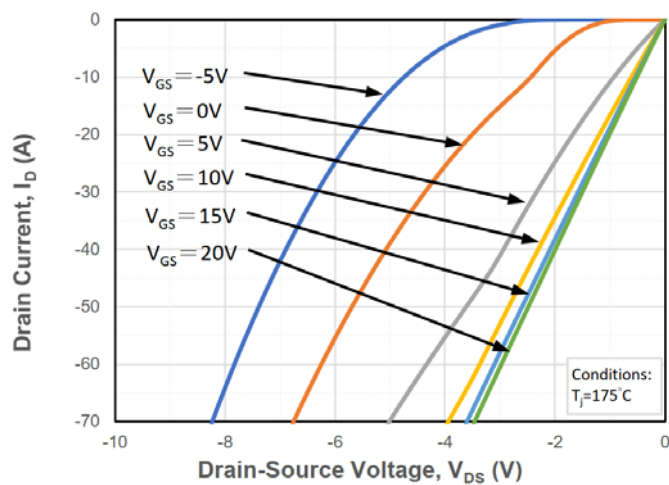

Figure 9. Reverse Output Characteristics at Tj = 175°C

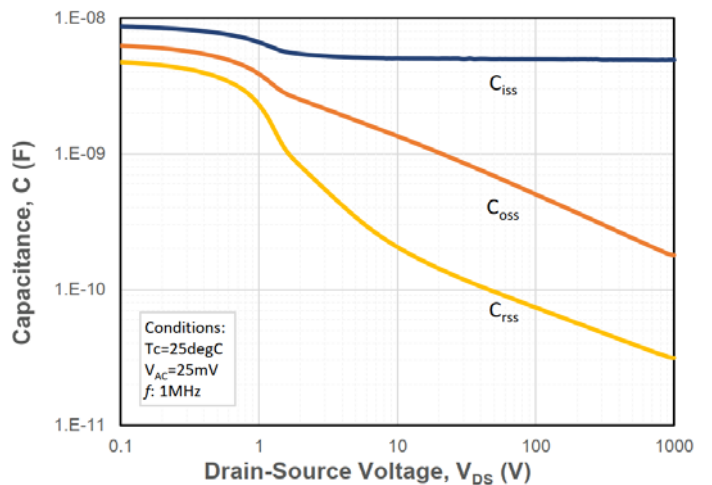

Figure 10. Capacitances vs. Drain to Source Voltage

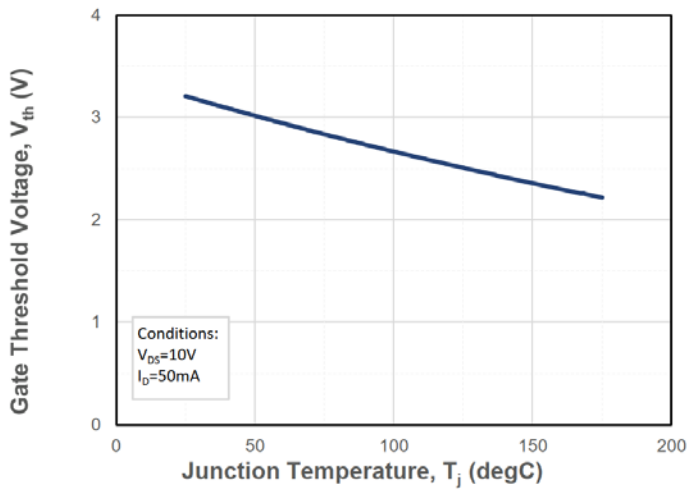

Figure 11. Threshold voltage vs.temperature

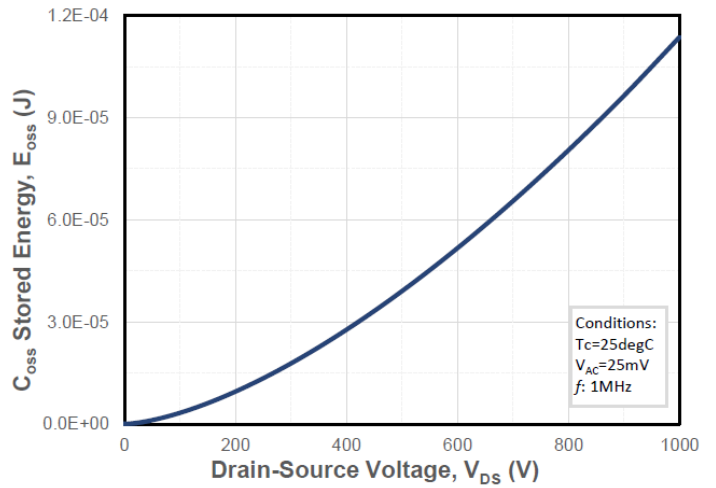

Figure 12. Output Capacitor Stored Energy

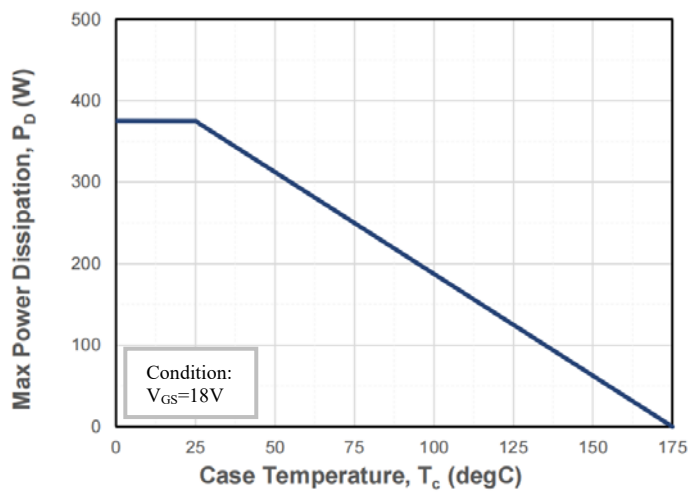

Figure 13. Maximum Power Dissipation Derating vs. Case Temperature

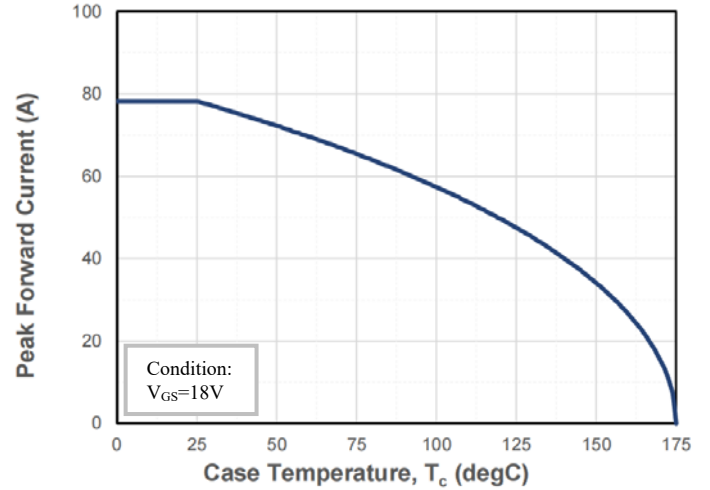

Figure 14. Drain Current Derating vs. Case Temperature

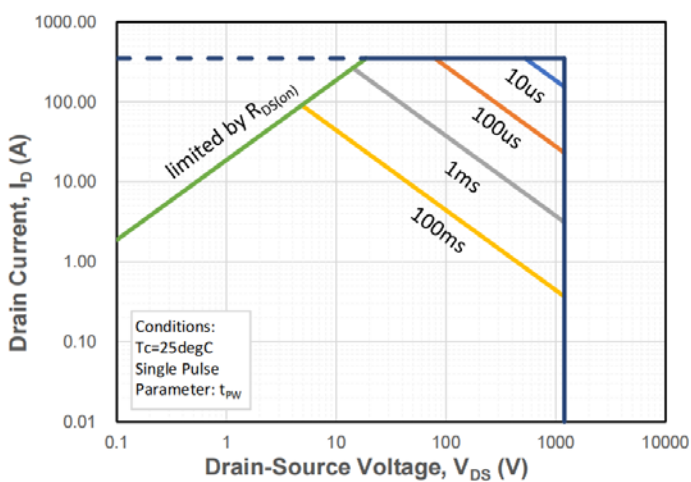

Figure 15. Safe Operating Area

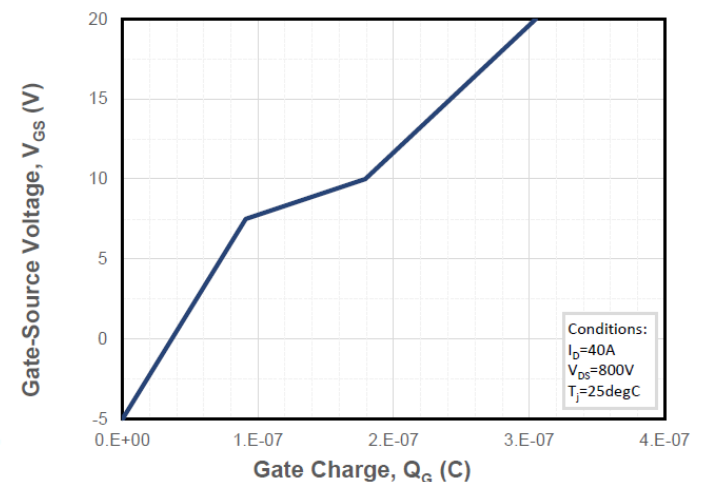

Figure 16. Gate Charge Characteristics

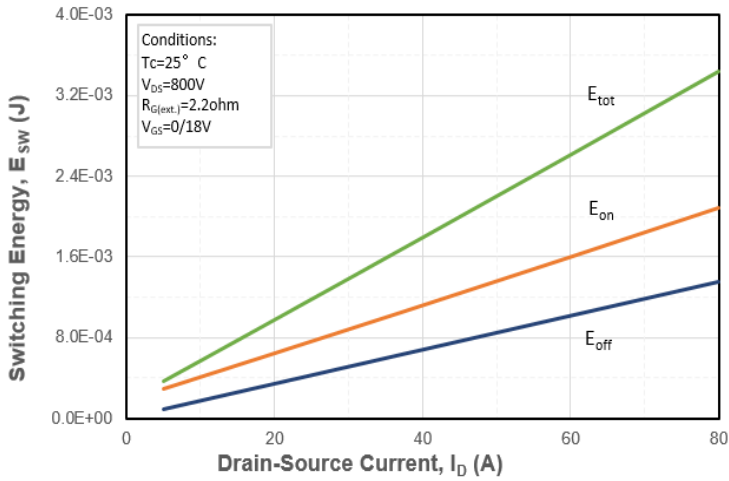

Figure 17. Clamped Inductive Switching Energy vs. Drain Current

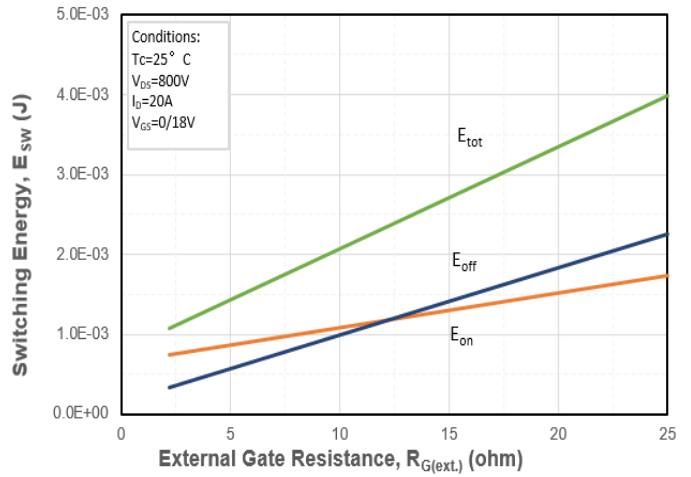

Figure 18. Clamped Inductive Switching Energy vs. External Gate Resistor ($R_{G(ext.)}$)

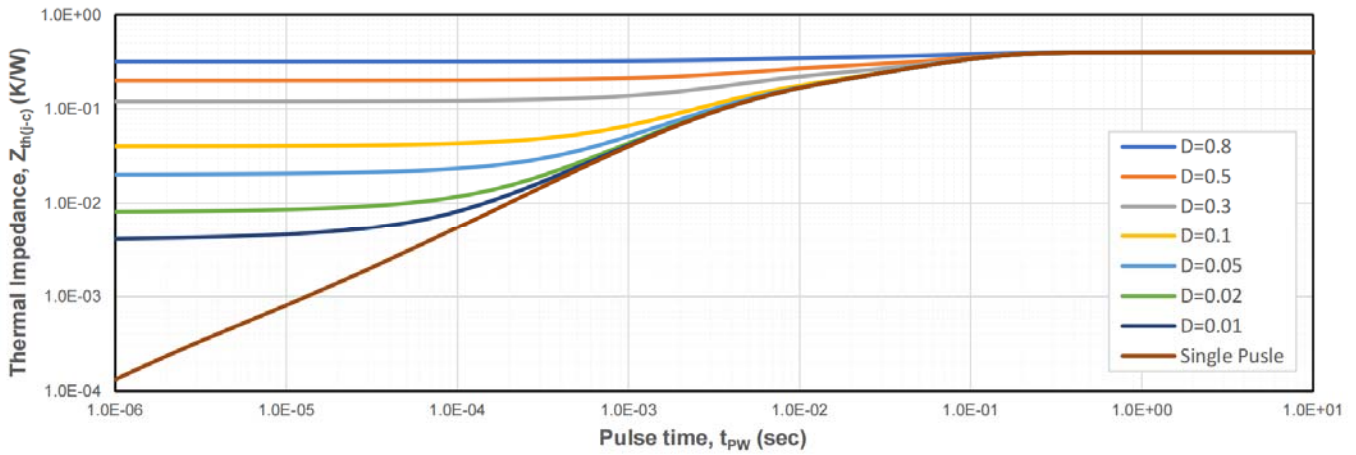

Figure 19. Transient Junction to Case Thermal Impedance

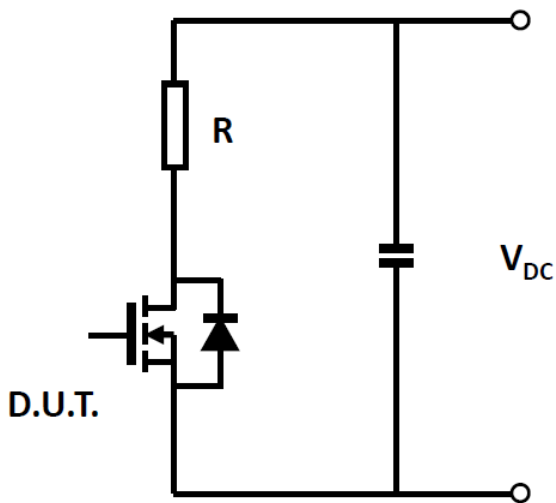

Figure 20. Schematic of Resistive Switching

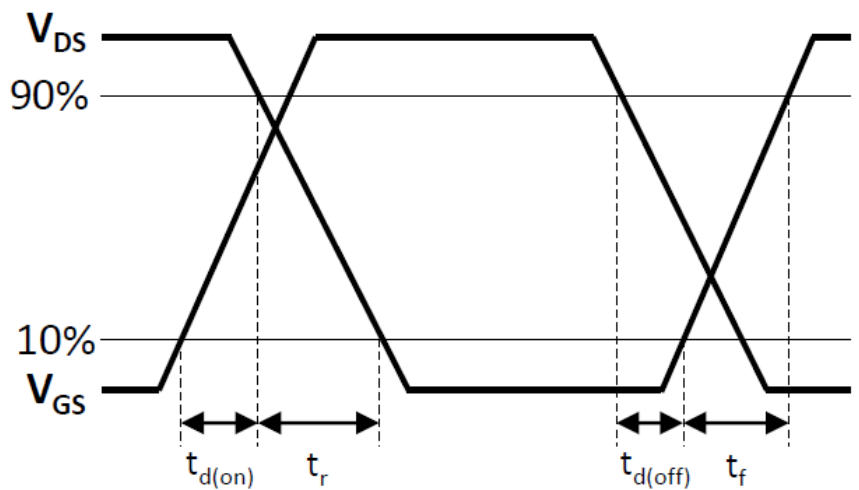
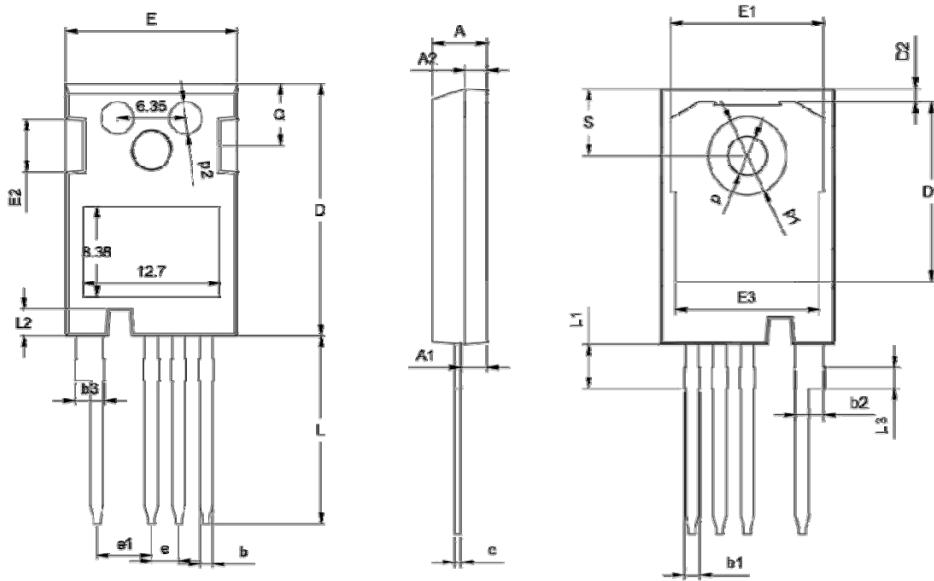

Figure 21. Switching Times Definition

■Outline Dimensions



TO247-4L			
Dim	Min	Norm	Max
A	4.80	5.00	5.20
A1	2.30	2.40	2.50
A2	1.88	1.98	2.08
b	1.10	1.20	1.30
b1	1.20	/	1.50
b2	2.35	2.55	2.75
b3	2.45	/	2.85
c	0.55	0.60	0.65
D	23.3	23.45	23.6
D1	16.25	16.55	16.85
D2	1.00	/	1.30
e	TYP2.54		
e1	TYP5.06		
E	15.75	15.90	16.05
E1	13.80	/	14.20
E2	4.40	4.75	5.10
E3	13.00	/	13.45
L	17.34	17.49	17.64
L1	4.00	/	4.30
L2	2.35	/	2.65
L3	TYP1.98		
Q	5.60	5.80	6.00
S	6.05	/	6.30
p	TYP3.58		
p1	TYP7.18		
p2	TYP3.00		



Disclaimer

The information presented in this document is for reference only. Yangzhou Yangjie Electronic Technology Co., Ltd. reserves the right to make changes without notice for the specification of the products displayed herein to improve reliability, function or design or otherwise.

The product listed herein is designed to be used with ordinary electronic equipment or devices, and not designed to be used with equipment or devices which require high level of reliability and the malfunction of which would directly endanger human life (such as medical instruments, transportation equipment, aerospace machinery, nuclear-reactor controllers, fuel controllers and other safety devices), Yangjie or anyone on its behalf, assumes no responsibility or liability for any damages resulting from such improper use of sale.

This publication supersedes & replaces all information previously supplied. For additional information, please visit our website [http:// www.21yangjie.com](http://www.21yangjie.com) , or consult your nearest Yangjie's sales office for further assistance.